Table of Contents

Workshop Network

Subject	Page
Workshop Network	3
Vehicle Bus Systems	3
Workshop Local Area Network (LAN)	4
Network Structure	5
Network Connections	6
Accessing Configuration Information	8
Workshop Layout	10
Workshop Network Components	12
Access Point	12
Wall Jack	12
CAT 5 Ethernet Cable	12
Switched Hub	12
Server	12
Common Terminology	13
Network	13
Local Area Network (LAN)	13
Ethernet	13
Ethernet Cable (CAT 5)	13
RJ-45 Connectors	13
Wall Jack	13
Switched HUB	14
Network Server	14
Automatic/Online Updates	14
Access Point	14
Interface Name	15
IP Address	15
IP Subnet Mask	15
Gateway	16

Workshop Network

Model: All

Production: All

OBJECTIVES

After completion of this module you will be able to:

- Identify the equipment used in the workshop network
- Determine what components make up a workshop network
- Understand the terminology used with regard to networks and configurations

Workshop Network

As the level of technology in our vehicles continues to increase so does the level of technology that we use in our diagnostic and programming equipment within the workshop.

In order to meet the ever growing demand for more rapid transfer of information we can no longer have multiple “stand alone” systems, therefore various infrastructures have been created to allow multiple “stand alone” devices/systems to interact with each other to share information.

The sharing of information with various control modules in our vehicles has been occurring for quite some time, now we will also be doing this with the diagnostic equipment in the workshop as well.

Vehicle Bus Systems

In order to make the components used in our vehicles more efficient we utilize bus structures (commonly referred to as I-Bus, K-Bus, D-Bus, DS2-Bus Byteflight, PT-CAN, etc.). By using bus structures in vehicles, we can accelerate communication between several different control modules.

Many common vehicle systems (such as entertainment, safety, powertrain, etc.) are “stand alone” systems but also require information from other modules/systems in order to be more efficient. In order to obtain the required information the systems must also be able to simultaneously communicate without interfering with each other, which is accomplished by using various bus structures.

Example:

The PDC receives information on vehicle speed from the ABS/ASC/DSC control unit.

To receive this signal, it is transmitted from:

- *ABS/ASC/DSC control unit to the IKE via the CAN-Bus,*
- *IKE control unit to the PDC control unit via the K-Bus splice (inside the BC1) control unit.*

The workshop network operates in a similar fashion.

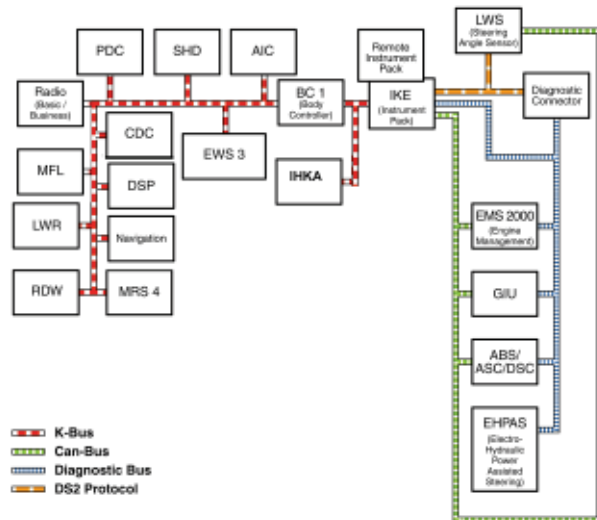

Workshop Local Area Network (LAN)

A network is nothing more than a group of devices interconnected so that they can communicate with each other. A LAN is a network that is localized to a specific area, such as a workshop or office.

The bus systems (I-Bus, K-Bus, PT-CAN, D-Bus,...) that we have been using in our vehicles for quite sometime, are nothing more than networks with different configurations.

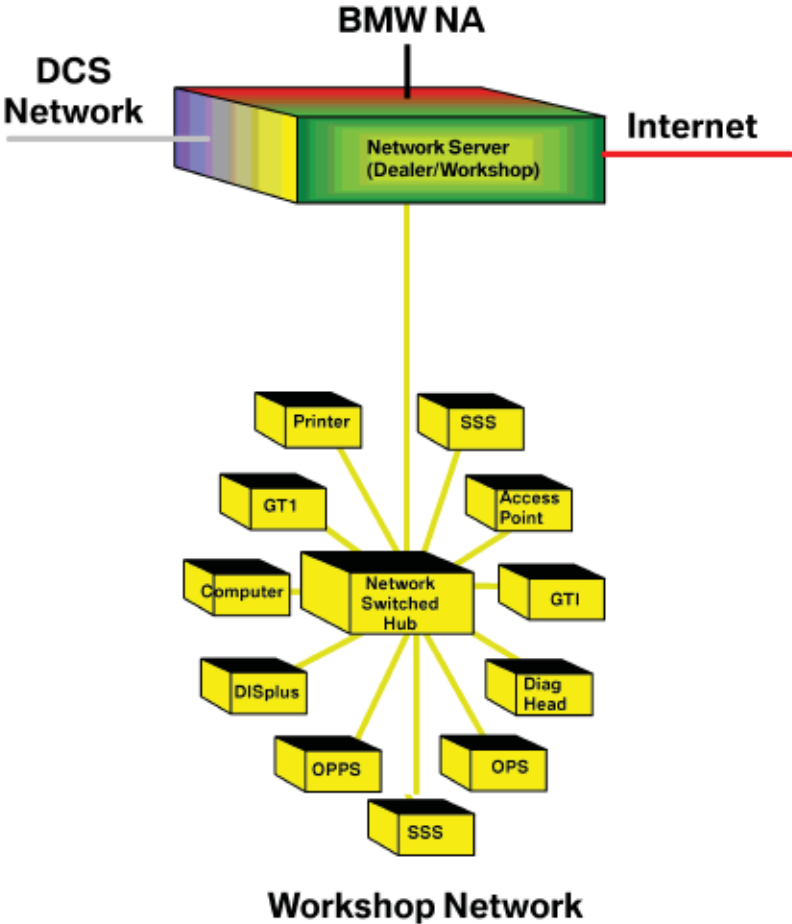

All workshops are currently equipped with a GT1, DISplus, SSS, Diagnostic Head, Access Point, desktop computer(s) and printer(s) which can be considered as satellite components (control modules/sensors).

In order for these components to communicate with each other, either directly or indirectly, they must be interconnected via a cable/wire to a common point or switching device. Consider the switching device/hub to be similar to the IKE, which monitors all devices connected to it and allows the devices to communicate with each other. The interconnection of these devices results in the establishment of a network localized to the workshop area thereby establishing a Local Area Network (LAN) in the workshop.

Network Structure

By having the workshop configured to allow the various devices used on a daily basis to be interconnected/networked with each other, as indicated in the illustration, additional components can easily be added and online updates can automatically be installed on all connected devices, as long as they have an approved IP address.

The network that exist in the workshop is not much different than the network structure that is used in our vehicles. In order for control modules to communicate with each other they must be correctly identified.

The identification process can be considered to occur as part of the coding procedure which is done at the end of the assembly process or at anytime a new component/module/system is added to the vehicle. By not recoding the vehicle after adding or removing a module/system, the communication on a particular bus can be hampered.

This is especially true:

- If a response from a module that is no longer installed is expected
- If a new module transmits data that is not expected by anyone else on the bus because it is not correctly identified

The VO for a vehicle can be considered to contain the IP addresses of the modules installed in the vehicle.

If the devices on the workshop network do not have a rigidly assigned IP address, online updates to specific devices can not occur. The operation/performance of a network can be greatly hampered if multiple devices share an address, since the transmitted data is not able to reach the correct device, it can result in jamming up the operation of the network.

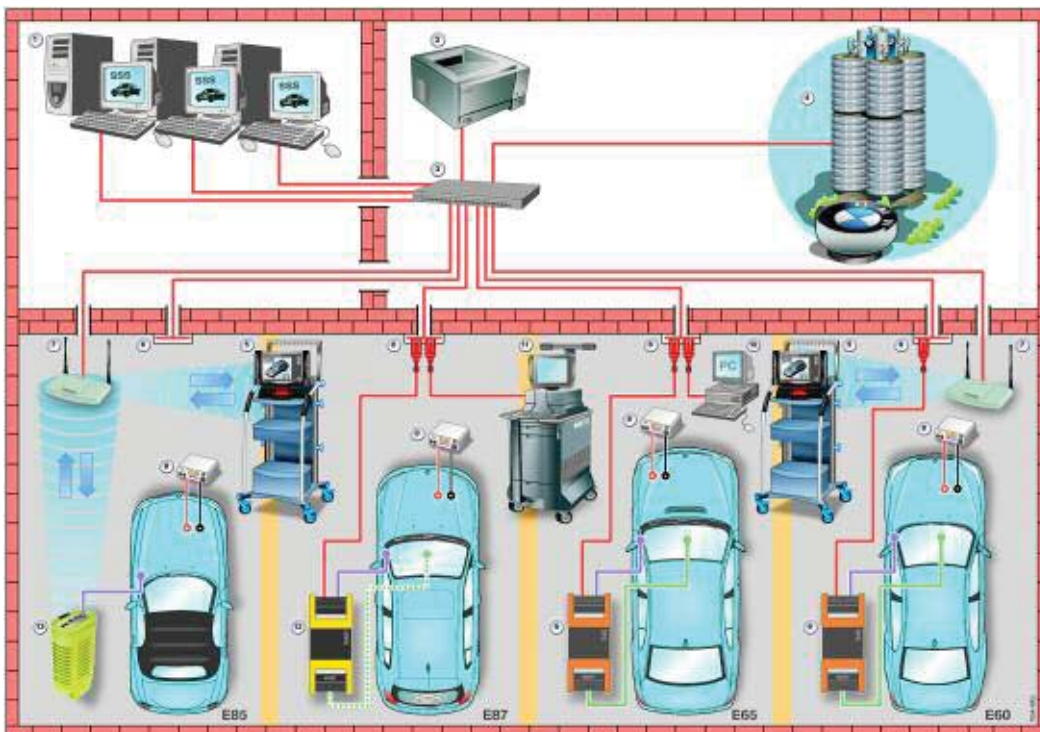

Network Connections

When establishing a network which will utilize multiple access terminals/jacks it is recommended that the jacks and cables attached to the specific jacks are numbered and that the corresponding end of the cable that connects to the router/switched hub should be numbered as well.

Example: *The illustration below shows a basic network structure with no miscellaneous devices connected, other than a Server and Switched Hub.*

The cables running to/from the Switched Hub are all numbered on both ends to make troubleshooting the network easier in the event of a problem with the cabling, wall jack or Switched Hub connections.

Not having the cable and wall jacks number would be like trying to troubleshoot a problem with an electrical circuit in the vehicle where all the wires are the same color and the components connected have no pin assignments.

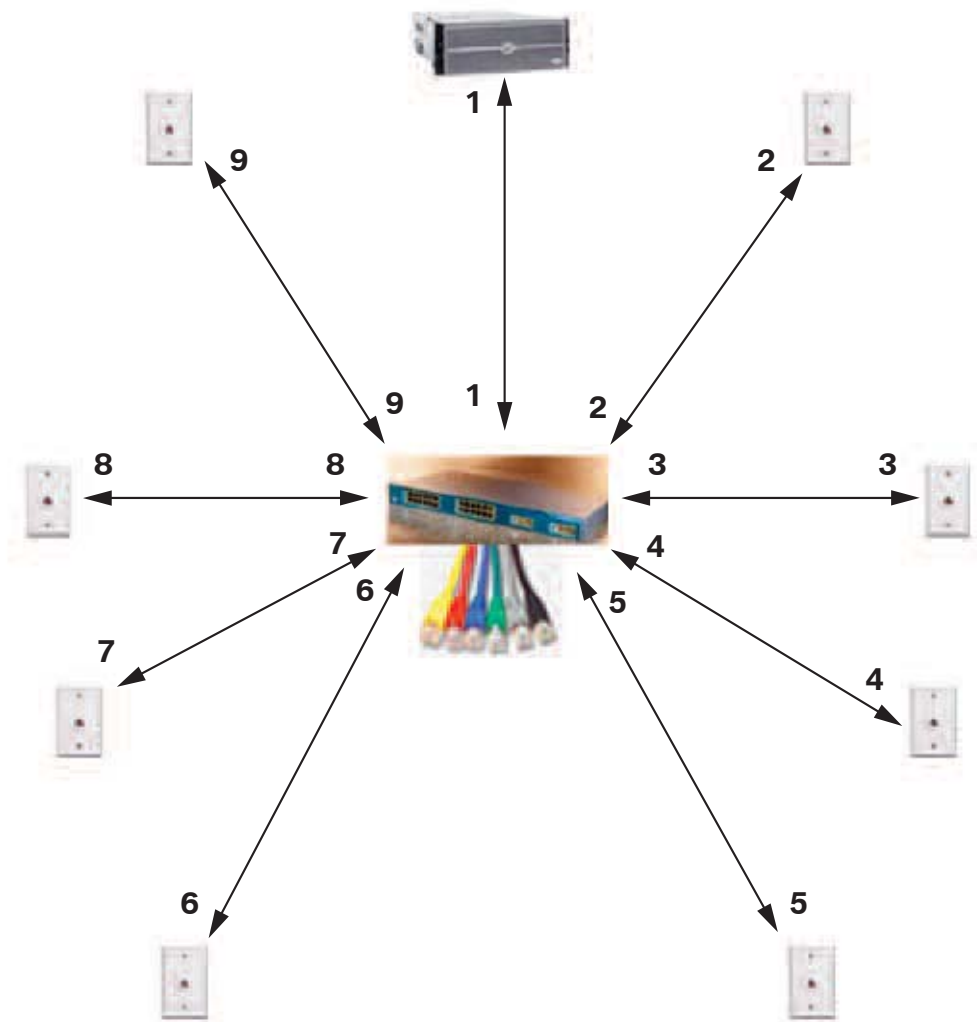

Network Connections

Once additional devices are connected it becomes very important that the configuration information (IP Address, Gateway Address, Subnet Mask and Device Name) is entered correctly for each device that is connected to the network. Each device must be assigned a specific/unique IP Address.

It is very important that the IP address not be shared by multiple devices located on the network, as this can result in “Locking-up” the network, which can have a detrimental effect on any control module(s) being programmed or coded.

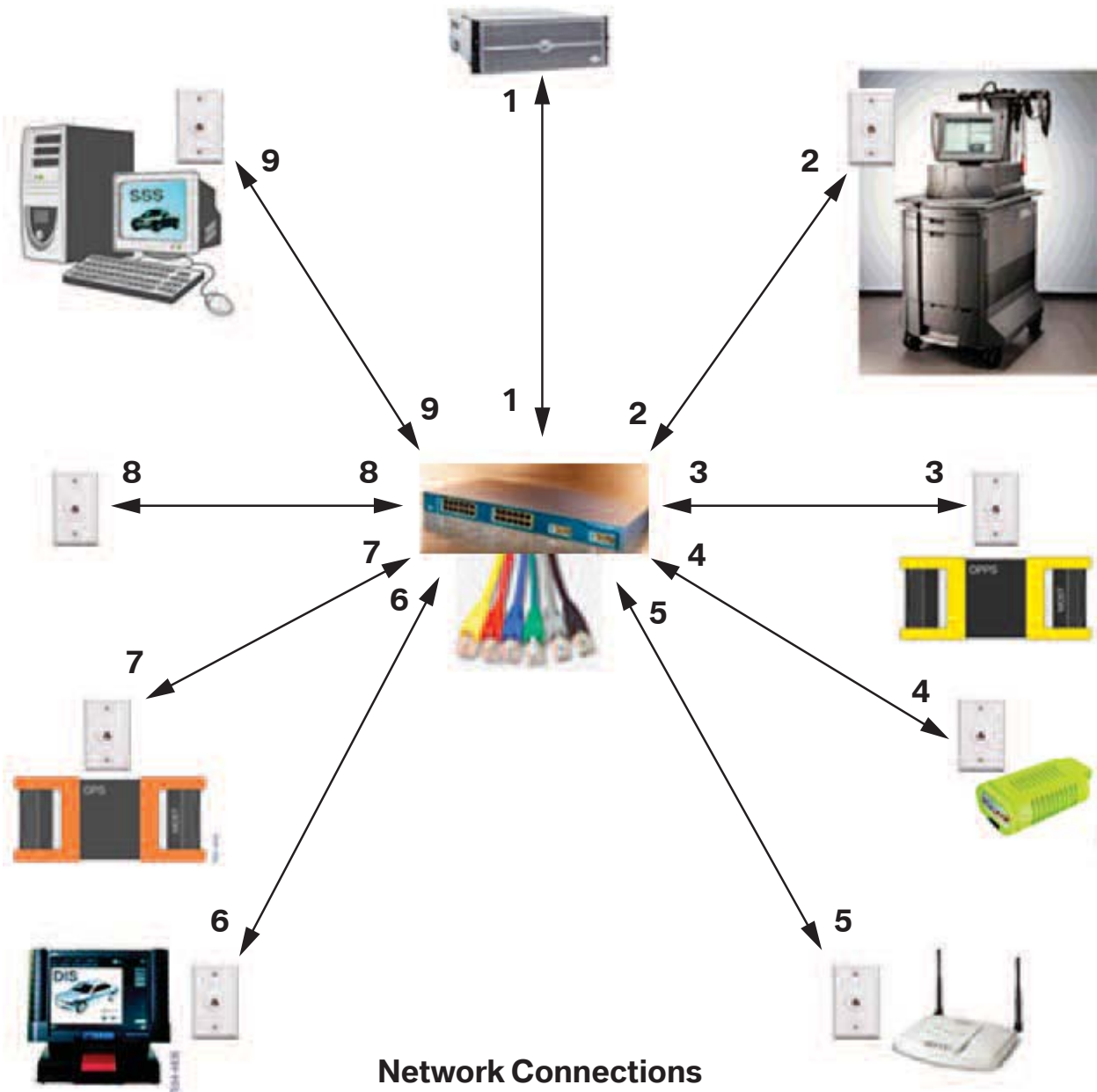

Accessing Configuration Information -DISplus & GT1

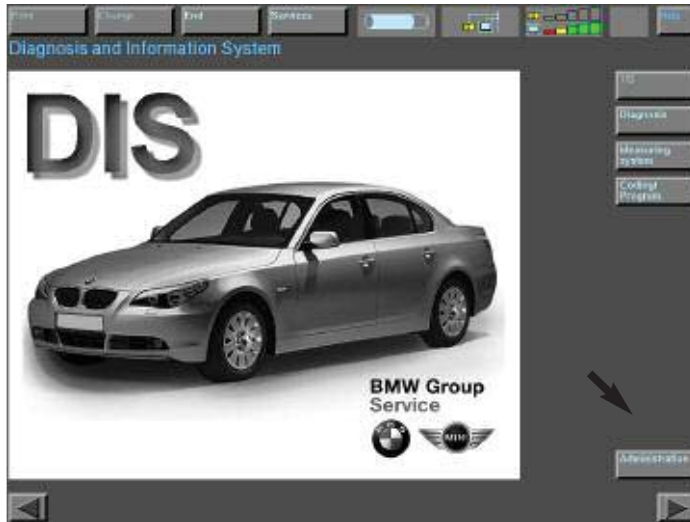

Select "Administration"

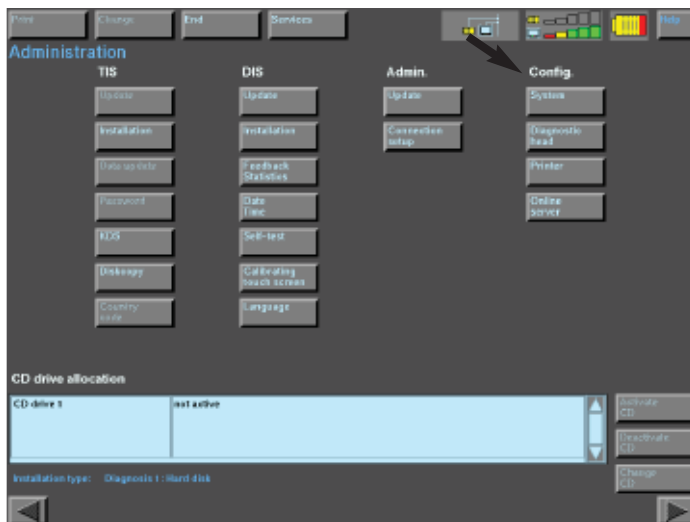

Select "System"

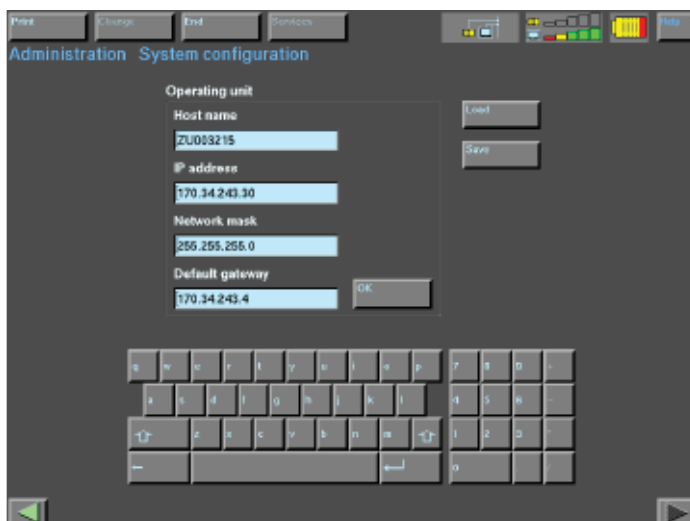

The screen now displays the network configuration information for the device being used DISplus/GT1.

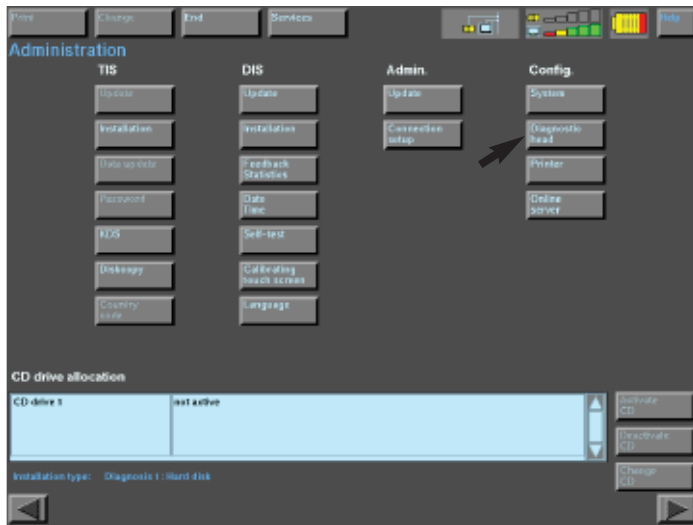

Select "Diagnostic Head"



Select "Free diagnostic heads"

NOTE: In order for an interface to be displayed it must be connected to a vehicle and the ignition turned on.

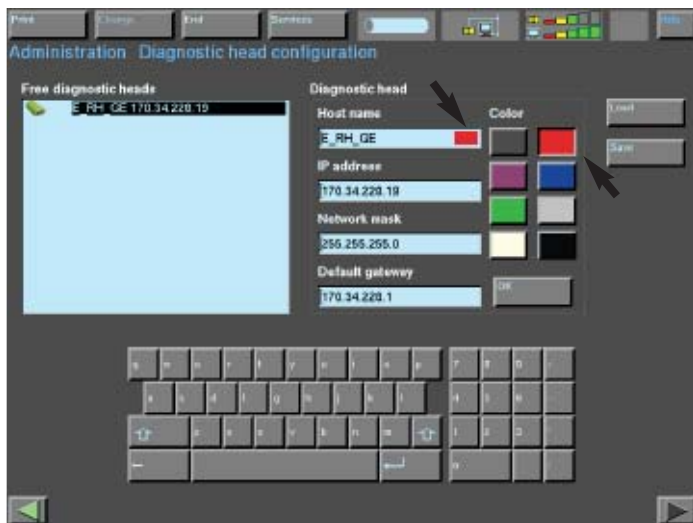

Network configuration information for the selected interface is displayed.

Example: A red color band will be assigned to this interface once "OK" is selected

Workshop Layout

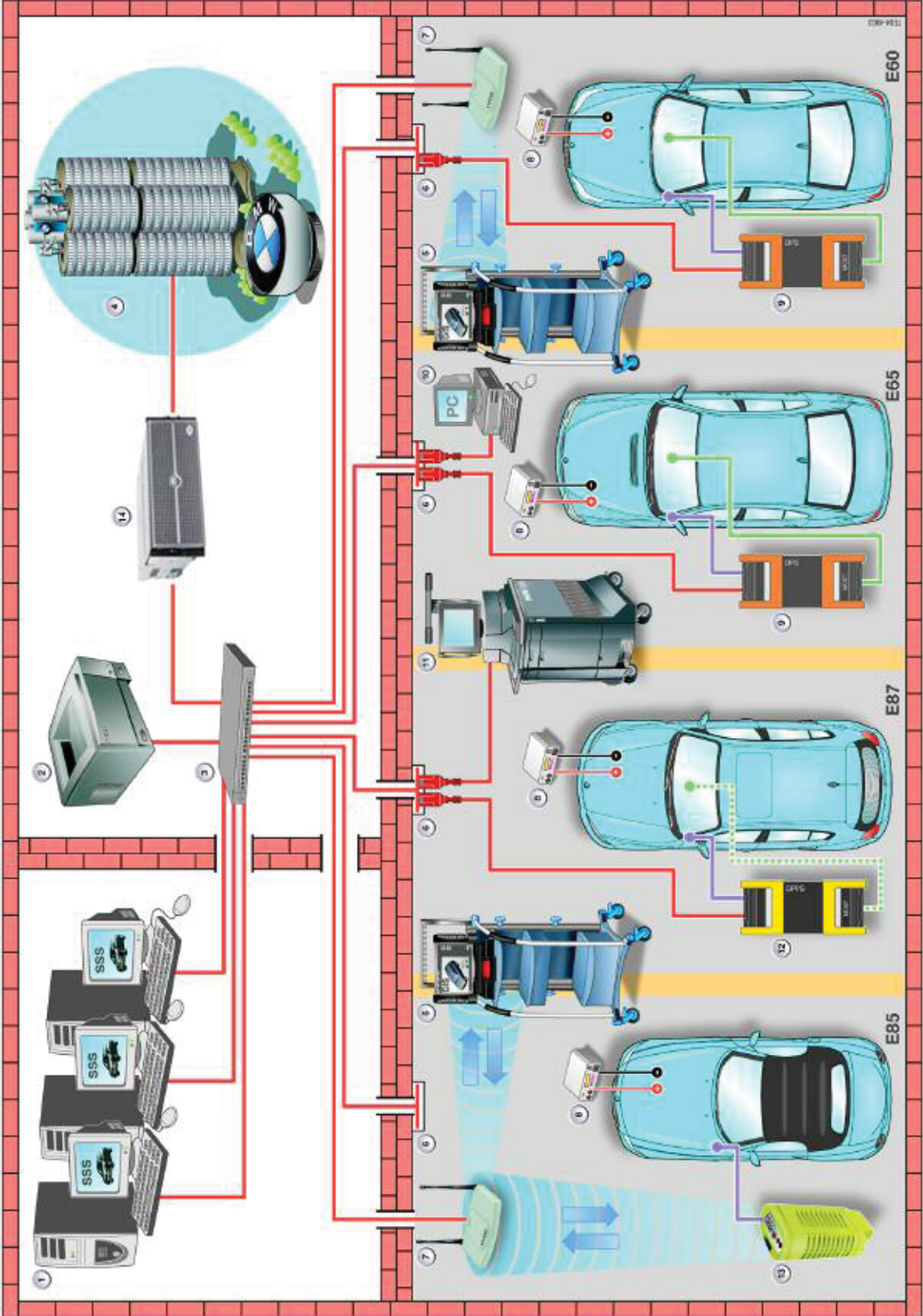

Workshop Layout Legend

Device #	Device Name/Description
1	Software Service Station (SSS)
2	Network Printer
3	Switched Hub (Cisco Switch WS C2950-24)
4	BMW Network
5	GT1
6	Wall Jack/Ethernet Connection point to workshop Network
7	Access Point
8	Deutronic Automatic Battery Charger
9	OPS
10	Workshop PC
11	DISplus
12	OPS Head
13	Diagnostic Head
14	Network Server

Workshop Network Components

A LAN currently exists in all workshops to allow the diagnostic equipment (DISplus, GT1, SSS, OPPS, OPS & Diagnostic Head) to communicate with each other. In order to successfully diagnose, code and program a vehicle, it is required to have all equipment connected to the workshop network.

Access Point

Allows direct wireless access to LAN for GT1 and Diagnostic Head **or** Diagnostic head establishes connection to LAN via wireless communication and thereby can be connected to DISplus or GT1, which are connected to LAN

Access point is connected directly to LAN. Symbol - Model Spectrum 24/AP 3020-100



Wall Jack

Connection point for devices such as GT1, DISplus, Access Point, SSS, Diagnostic Head, OPPS/OPS Head, Printer and Network Server to Switched Router via RJ45 cable.



CAT 5 Ethernet Cable

Used to establish a connection between:

- Wall jack and Switched Router/Hub
- Wall jack and devices such as GT1, DISplus, Access Point, SSS, Diagnostic Head, OPPS/OPS Head and Network Server.



Switched Hub

LAN switched distribution hub for all devices connected to the network. Routes communication telegrams / messages to specific devices from specific devices. Allows multiple devices to communicate with each other without reducing data transfer rate.

Cisco Switch WS-C2950-24



Server

Central computer which controls interface/communication between all devices on the Workshop LAN and communication to external networks and internet. Keystone device for network operation along with switch/router.



Common Terminology

Network

A group of computers that are interconnected with each other and able to communicate with each other either by transferring data via a wired or wireless connection.

Local Area Network (LAN)

A network that exists within a specific area.

Example: *By having all computers, testers and printers in the workshop interconnected results in a Workshop LAN.*

Ethernet

The term Ethernet is a communications protocol used to define a method & speed by which interconnected devices are able to communicate with each other by either a wired (twisted pair) or fiberoptic connection.

Common Ethernet communication protocol terms:

10BaseT - Able to transmit data at a rate of 10Mbps for a maximum distance of 100 meters per segment.

100BaseT - Able to transmit data at a rate of 100Mbps for a maximum distance of 1000 meters per segment.

The speed differences are obtained by modifying the method of encoding the data to be transferred. The maximum distance consist of the distance from switched hub to wall jack plus length of cable used to connect a particular device. The greater the distance the greater the chance of signal loss/disturbance.

Ethernet Cable (CAT 5)

A standard used to define an 8 wire cable (4 twisted pair) that is commonly used to interconnect various computers in the establishment of an ethernet network. Certified to transmit data at a maximum rate of 100Mbps.

RJ-45 Connectors

The plastic connectors at the end of a CAT 5 cable, used to connect the cable to device/computer, wall jack and hub.

Wall Jack

Accepts RJ-45 connectors when connecting devices to the network. Connection point for devices like DISplus, GT1, SSS, Diagnostic Head, workshop computers and printer.

Recommendation is that outlet/jack is numbered and the corresponding end of the ethernet cable connected to the switched hub is numbered as well, to assist in troubleshooting in the event of a problem.

Example: *A wall jack outlet is labeled as #1 the other end of the cable at the hub should also be labeled #1.*

Switched HUB

Allows multiple devices to send information over the network at the same time without slowing down the communication process. A switched hub essentially isolates the two devices that are communicating, thereby providing each component on the network a separate connection at the maximum data transfer rate of the network.

Example: *A switched HUB is similar to the use of cloverleaves on the highway, traffic does not need to stop if a change in direction needs to be made, plus traffic flows smoothly from point to point.*

A regular HUB does not provide each component with a separate connection point to the network but rather a shared connection point. By sharing a connection point the data transfer rate of the network is reduced when multiple devices try to communicate.

Example: *A regular HUB is similar to the use of a 4 way intersection, the smaller the amount of traffic using the intersection the quicker a car can go through the intersection and reach its desired destination. The greater the traffic the longer it will take for a car to reach its desired destination.*

The switched hub installed as part of the workshop wiring project is a Cisco WS-C2950-24.

Network Server

A computer that provides information/data to other computers located on the network. A server allows computers on its network to access information on another network, such as the internet. The server is the keystone device that allows computers on its specific network to access information on another network.

As an example a server can obtain and distribute software updates to all computers located on its network, instead of having to physically install the updates to each computer individually.

Automatic/Online Updates

The ability to connect the network server to the BMW server and check for new software updates (Diagnostic, Coding & Programming data) then downloads the information to all computers/equipment located on the network automatically at a specific time.

Example: *New updates can be installed on SSS, GT1 and DISplus overnight in order to have latest data available the next morning.*

The application that performs online updates is referred to as JETstream.

Access Point

The access point is a wireless communication device that is able to establish a wireless connection with a GT1 and/or a diagnostic head and allows them to communicate with other devices on the network.

Manufactured by Symbol - Model Spectrum 24 /AP 3020-100

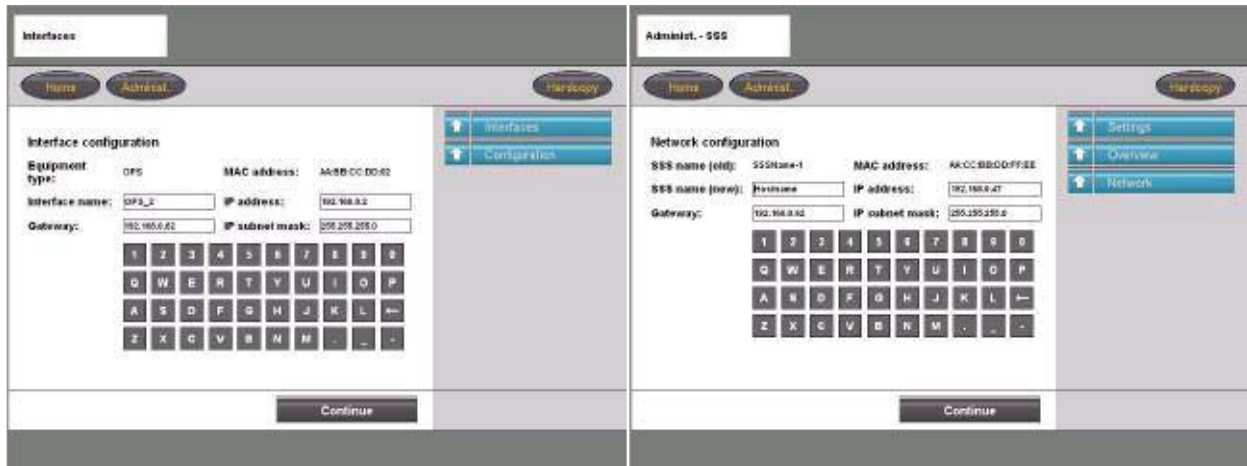

Interface Name

The specific name assigned to the device (Ex. Diagnostic Head Blue A)

IP Address

It is a unique four segment number used to identify a specific device located on a specific network. The number represents the address of the device on the network and is necessary when communicating with other devices located on the network.

Example: 92.168.100.10

Usually the first three segments are used to identify the network and the last segment identifies the device. The IP Subnet Mask information generally defines which segments are needed to identify the network and which identify the device.

In order for a devices on the network to communicate with other devices on the network it must know the addresses of those devices. If a print command is sent from a computer to a printer on the network, the command must be addressed specifically to the desired printer.

Example: *An IP address is no different than your home address, in order to receive a letter specifically directed to you, your name and address must be correctly displayed on the letter.*

IP addresses are assigned by the network administrator/provider and are rigidly assigned to the device(s) located within the workshop network, by entering it into the device during the initial setup.

IP Subnet Mask

This information is used to define which segment(s) of the four segment IP address specifically identifies the device and which identify the specific network.

Example: 255.255.255.0

Indicates that the first three segments (255.255.255) identify the specific network that the device is located on. The last segment (0) indicates that this is the segment that will identify the specific device.

Gateway

This information identifies the four segment address of the component located on the network responsible for communicating from the current network to another network. If there is no address in this location then a connection to any devices outside of the current network can not be established.

Note: The network and device address information must be entered exactly as defined by the network administrator for your facility, otherwise the devices can not be accessed.